

# The Multipath Estimating Delay Lock Loop : Approaching Theoretical Accuracy Limits

IEEE Position, Location and Navigation Symposium  
Las Vegas, Nevada, April U-15, 1994

*Richard DJ. van Nee and Jaap Sierveld*  
Delft University of Technology P.O.Box 5031, 2600 GA Del' The Netherlands

*Patrick C Fenton and Bryan R Townsend*  
NovAtel Communications Ltd Calgary, Alberta, Canada

**Abstract:** This paper demonstrates that it is possible to largely reduce GPS code and carrier multipath errors by using a specific receiver structure which simultaneously estimates the parameters of line-of-sight plus multipath signals. Test results in various environments show an error reduction up to a factor of ten, as compared to a receiver with a small early-late spacing.

## INTRODUCTION

It is widely recognized that multipath propagation is the main error source in differential GPS applications. Till now, however, receivers hardly use specific counter measures against multipath. Decreasing the early-late spacing -like some manufacturers did- is a step in the right direction. However, carrier range errors are not reduced at all by this technique, while the remaining code range errors can still be considerable.

This paper demonstrates that it is possible to largely reduce both code and carrier multipath errors by using a specific receiver structure which simultaneously estimates the parameters of line-of-sight plus multipath signals. The paper starts with the theoretical background of this new technique, called the Multipath Estimating Delay Lock Loop (MEDLL). Then, some implementation issues are discussed, after which a number of measurements are shown, which clearly demonstrate the advantages of the MEDLL as compared to a conventional receiver with a small early-late spacing.

## THE MULTIPATH ESTIMATING DELAY LOCK LOOP

The MEDLL was introduced in [1,2]. In order to understand this technique, a brief summary will be given on the theory behind the MEDLL.

In the presence of multipath propagation, the received signal at the input of a GPS receiver can be written as:

$$r(\tau) = \sum_{i=0}^M a_i p(\tau - \tau_i) \cos(\omega\tau + \theta_i) + n(t) \quad (1)$$

where  $p(t)$  is the spread-spectrum code and  $n(t)$  is white Gaussian noise. In the case of GPS, the parameters of interest are the line-of-sight signal delay and phase. However, due to multipath, a conventional delay lock loop is not able to measure these parameters correctly. The MEDLL avoids this problem by taking into account the multipath signals. According to maximum likelihood estimation theory, the MEDLL calculates those estimates which minimize the mean square error  $L(\hat{a}, \hat{\tau}, \hat{\theta})$ :

$$L(\hat{a}, \hat{\tau}, \hat{\theta}) = \int_{\tau-T}^{\tau} [r(\tau) - s(\tau)]^2 d\tau$$

$$s(\tau) = \sum_{i=0}^M \hat{a}_i p(\tau - \hat{\tau}_i) \cos(\omega\tau + \hat{\theta}_i) \quad (2)$$

where  $s(t)$  is the estimate of the line-of-sight plus multipath signals. Equation (2) can be solved by setting the partial derivatives of  $L(\hat{a}, \hat{\tau}, \hat{\theta})$  to zero. The resulting equations are:

$$\hat{\tau}_1 = \max_{\tau} \{ \text{Re} [ R_x(\tau) - \sum_{m=0}^M a_m R(\tau - \hat{\tau}_m) \exp(j\hat{\theta}_m) ] \exp(-j\hat{\theta}_1) \}$$

$$a_1 = \text{Re} \{ [ R_x(\hat{\tau}_1) - \sum_{m=0}^M a_m R(\hat{\tau}_1 - \hat{\tau}_m) \exp(j\hat{\theta}_m) ] \exp(-j\hat{\theta}_1) \}$$

$$\hat{\theta}_1 = \text{arg} [ R_x(\hat{\tau}_1) - \sum_{m=0}^M a_m R(\hat{\tau}_1 - \hat{\tau}_m) \exp(j\hat{\theta}_m) ] \quad (3)$$

In (3),  $R_x(\tau)$  is the in-phase / quadrature down converted correlation function and  $R(s)$  is the reference correlation function. Basically, solving the MEDLL equations is like performing a nonlinear curve fit; find a set of reference correlation functions with a certain amplitude, phase and delay which give the best possible fit on the input correlation function. Essentially, a conventional receiver is doing the same thing, but for only one signal - the line-of-sight. When there is multipath present, the MEDLL can improve the curve fit by increasing the number of estimated signals  $M+1$  in (3), thereby separating line-of-sight and multipath signals. As a result of this patented MEDLL technique, the code and carrier range errors caused by multipath are greatly reduced. In the end, only noise is the limiting factor, which gives the following lower bounds on the accuracy of code and carrier observables [4,5]:

$$\sigma_{\tau} = \frac{c}{T_c} \sqrt{\frac{B_L d}{2C/N_0}} \quad [m]$$

$$\sigma_{\theta} = \frac{\lambda}{2\pi} \sqrt{\frac{B_L}{C/N_0}} \quad [m] \quad (4)$$

where  $B_L$  is the equivalent noise bandwidth of the tracking loop,  $C/N_0$  is the signal-to-noise power density ratio,  $c$  is the speed of light,  $\lambda$  is the carrier wavelength and  $d$  is the early-late spacing of the code tracking loop in chips. Typical values for GPS are  $C/N_0 = 40$  to  $50$  dB-Hz,  $d = 0.1$  to  $1$ ,  $B_L$  is  $0.5$  to  $16$  Hz for the carrier tracking loop and  $B_L$  is  $0.05$  to  $0.5$  Hz for the code tracking loop [4,5]. These parameter values result in carrier noise errors ranging from  $0.1$  to  $1$  millimetre and code noise errors ranging from  $8$  centimetre to  $1.5$  meter. Conventional GPS receivers are usually far away from these lower bounds, because of multipath [3,5]. The task of the

MEDLL is to shrink this gap between theory and practice as much as possible.

## IMPLEMENTATION ISSUES

The MEDLL has been implemented in a prototype NovAtel GPS receiver. A block diagram of this receiver is depicted in figure 1.

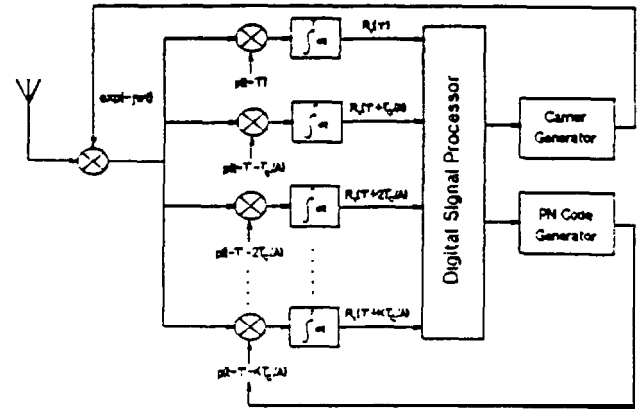
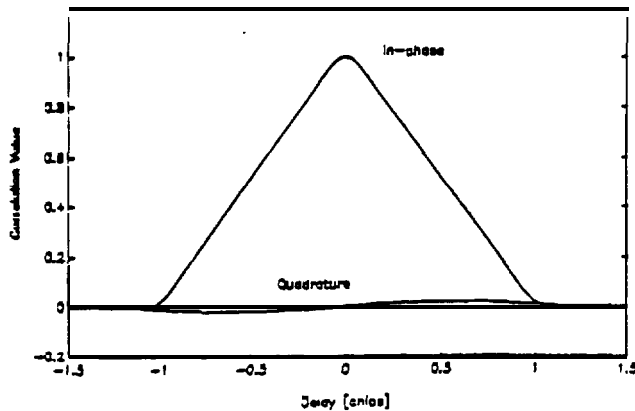

Fig. 1: MEDLL block diagram.

After down conversion, the received signal is correlated with a number of complex correlators to get samples of the input correlation function  $R_x(\tau)$ . In order to reduce the complexity, the receiver employs a conventional carrier tracking loop which tracks the phase of the correlation sample with the highest amplitude. The phase estimates are used to compensate for phase and frequency errors and also to remove data from the input correlation samples. Finally the correlation samples are averaged over a period of one second or more, after which the MEDLL equations can be calculated. The resulting delay estimate can be used to control the code generator in order to keep the line-of-sight correlation peak in the delay window. Besides the MEDLL estimates, the processor also calculates a normal DLL estimate of the line-of-sight delay, using an early-late spacing of one tenth of a chip. In this way, the MEDLL performance can be compared with the best possible DLL performance.

An important aspect of the MEDLL is an accurate reference correlation function. Figure 2 shows the reference function that is used in our prototype receiver. It was constructed by averaging measured

correlation functions over a **total** averaging time of 400 seconds, in order to obtain a negligible noise level. Further, the measurement was taken at a place with very little multipath. Notice that the reference function only covers the main correlation **peak** since we are only interested in multipath signals with relative delays up to about one chip time, the reference function only has to be two chips wide.



**Fig. 2 Reference correlation function**

An interesting fact is that all satellites do not have exactly the same reference function. Due to the auto correlation properties of the Gold codes, there are in fact three different functions. The value of  $R(\tau)$  at  $\tau = \pm T_c$  can be  $-1/1023$ ,  $63/1023$  or  $-654/1023$  for unfiltered axes. In the case of filtered codes, these values are slightly larger.

### MEASUREMENTS

Several measurements were made in various environments in order to test the prototype MEDLL. First a relatively multipath free location was used to determine the noise floor and to obtain a good **reference** correlation function. Figure 3 shows DLL and MEDLL errors while the antenna was situated on a flat roof, which acts like a very large groundplane, so multipath from the ground is greatly reduced. After approximately 350 seconds, the antenna was moved to the edge of the building, in order to measure the effect of an increased ground reflection. During the last two minutes, the antenna was moved away from the edge to decrease the multipath level again. The antenna movements are

clearly visible in the measurement. During the first 350 seconds, the DLL and MEDLL code range errors have a standard deviation of 14 (d=0.1), 25 (d=1) and 13 cm, respectively. The carrier-to-noise density  $C/N_0$  was 46 dB during the measurement, so the theoretical noise limit for the prototype receiver is about 7 centimetre, according to equation (4) for an early-late spacing d of 0.1. Notice that the different errors have been given an offset for readability of the plot. Further, the scales of all measurements are relative, since absolute range values are not known.

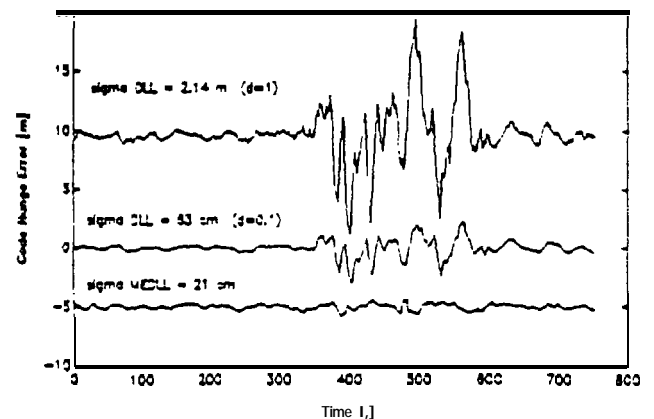

**Fig. 3: DLL and MEDLL code range errors, measured on top of the Electrical Engineering building, using  $B_L=0.05$  Hz and  $M=1$ .**

From 350 to 650 seconds, when the antenna was on the edge of the building, the standard deviation of the DLL and MEDLL errors increased to 98 (d=0.1), 366 (d=1) and 27 cm, respectively. This clearly shows the ability of the MEDLL to estimate the multipath parameters and to reduce their influence on the line-of-sight estimates. Further, it demonstrates the advantage of using a small early-late spacing, as already mentioned in [3,4]. In order to make a fair comparison between a conventional DLL and the MEDLL, a small early-late spacing will be used in all following measurements.

To measure the improvement of the MEDLL under severe multipath conditions, we did several measurements in the vicinity of buildings. Figure 4 and 5 show examples of the resulting code range errors in cases of very strong specular multipath.

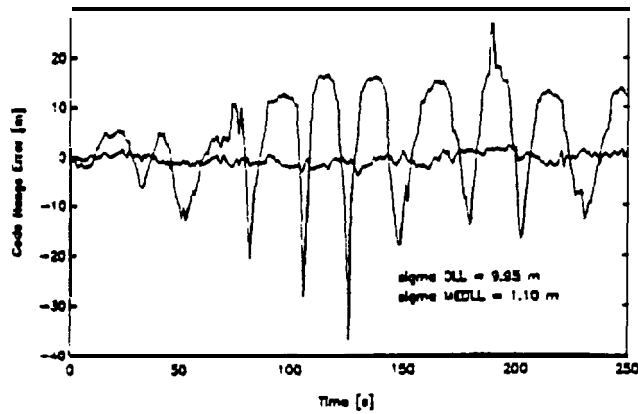

**Fig 4: DLL and MEDLL code range errors near the building of Electrical Engineering using  $B_L=0.5$  Hz,  $d=0.1$  and  $M=1$ .**

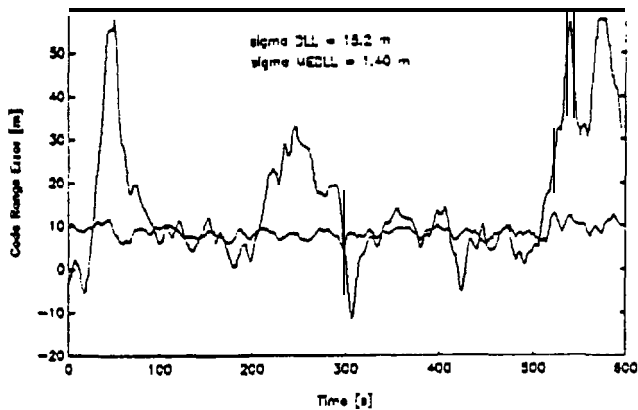
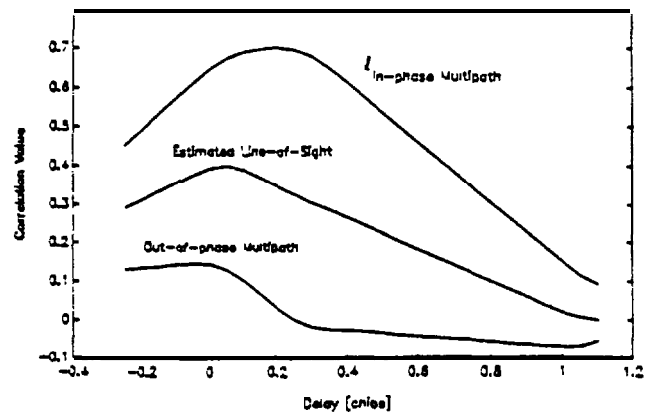

**Fig 5: DLL and MEDLL code range errors due to an apartment building using  $B_L=0.1$  Hz,  $d=0.1$  and  $M=1$ .**

As can be seen, the MEDLL gives an improvement of about a factor of ten. There seems to be no correlation between the DLL errors and the remaining MEDLL errors, which suggests that those remaining errors are caused by other multipath signals. However, calculating the MEDLL estimates for more than one multipath signal did not give a significant improvement. Most probably, the remaining errors are caused by multipath signals with small relative delays, which are difficult or even impossible to eliminate, like already mentioned in [1,2].

Another phenomenon which can be observed in figures 4 and 5 is that multipath delay errors of a conventional DLL with a small early-late spacing  $d$  can become much larger than  $d/2$  which corresponds to a range error of 15 meter for  $d$  is one tenth of a c/a-code chip. This is an effect of the band pass filtering of the GPS signals, which changes the ideal triangular correlation function into a smooth shape like depicted in figure 1. As explained in [3], due to this band limitation the multipath delay errors can reach values up to half a chip (150 meter for the C/A code) when the signal-to-multipath ratio approaches one, independent of the early-late spacing.

Figure 6 shows how strong the input correlation function can be affected by multipath. Two measured correlation peaks from the same measurement as figure 5 are drawn, together with an estimate of the line-of-sight correlation peak. Only a part of the peaks is drawn, since the prototype receiver does not provide samples of the entire correlation peak. The distortion of the ideal correlation shape caused by in-phase and out-of-phase multipath is clearly visible in figure 6. Notice that in the use of out-of-phase multipath, the resulting correlation function is almost flat where the leading edge of the line-of-sight peak is supposed to be. This is a sign that the reflection amplitude is almost equal to the amplitude of the line-of-sight signal. The MEDLL indeed estimated a signal-to-multipath ratio around 0 dB at those moments where the DLL range errors exceeded 15 meter.



**Fig 6: Correlation function in case of in-phase and out-of-phase multipath**

The figures 7 and 8 show two examples of relatively moderate multipath levels, measured on top of the Electrical Engineering building. The GPS antenna was in the vicinity of a number of large parabolic dishes, which cause multipath signals with relative short delays. As explained in [2], these multipath signals are difficult to estimate and hence their errors are only partially reduced by the MEDLL, which is clearly visible in the beginning of figure 8. Nevertheless, in both measurements the MEDLL improved the standard deviation by more than a factor of two

Since the measurements of figures 7 and 8 are quite long, there was a significant change of the ionospheric error. Therefore, a parabolic curve fit was performed on the MEDLL errors in order to estimate and the relative ionospheric error, which then was subtracted from the range measurements.

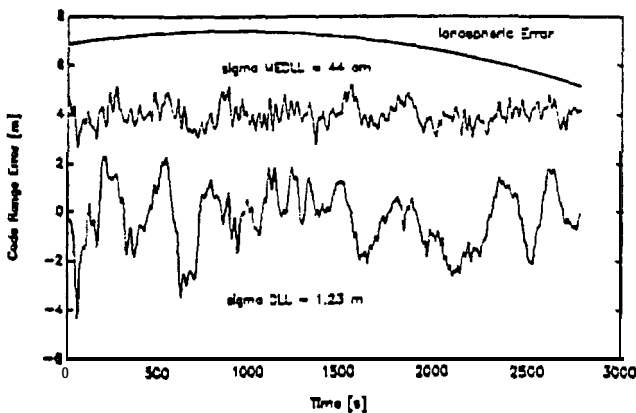

Fig. 7: **DLL and MEDLL code range errors, measured on top of the Electrical Engineering building using  $B_L=0.05$  Hz,  $d=0.1$  and  $M=1$ .**

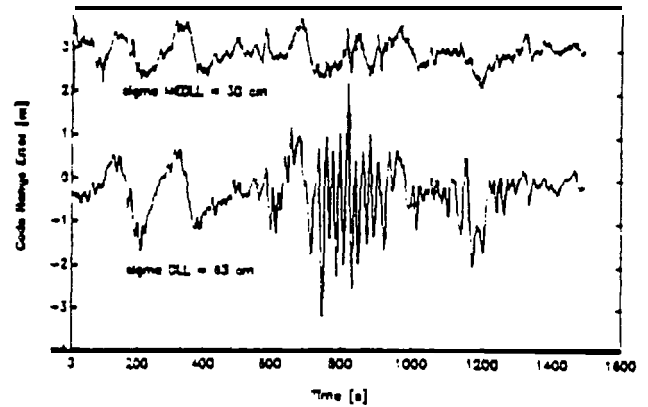

Fig. 8: **DLL and MEDLL code range errors, measured on top of the Electrical Engineering building using  $B_L=0.05$  Hz,  $d=0.1$  and  $M=1$ .**

As stated earlier, one of the advantages of the MEDLL is that it also reduces carrier range errors caused by multipath. Unfortunately, this is difficult to prove using the present prototype receiver, since it employs a conventional carrier tracking loop in order to simplify the carrier phase tracking. The MEDLL then only has to calculate carrier range corrections once per second or whenever they are needed. In order to verify these MEDLL carrier range corrections, a second receiver would be necessary. However, by looking at figure 9, which shows the MEDLL carrier range corrections together with measured DLL code range errors, it can be concluded that the phase estimation seems to work properly. The estimated carrier range error is maximum or minimum when the code range error is zero and vice versa, just as predicted and demonstrated in [3].

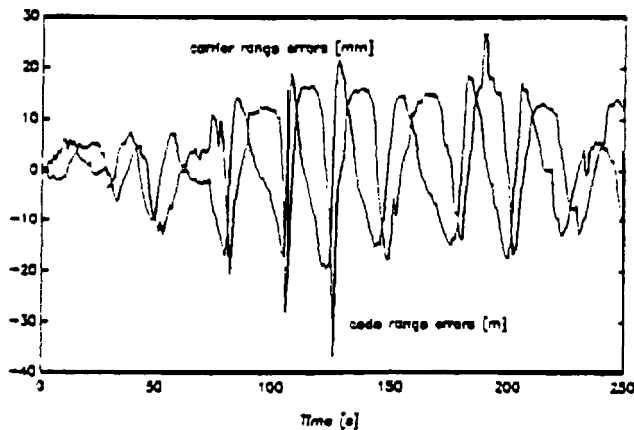

Fig 9: *DLL* code range errors and *calculated carrier range errors*, using  $B_L=0.5$  Hz,  $d=0.1$  and  $M=1$ .

### CONCLUSIONS

The MEDLL has been implemented in a prototype NovAtel GPS receiver. Test results in various practical situations show that code and carrier errors are greatly reduced as compared to the errors of a standard GPS receiver, using a small early-late spacing. The MEDLL makes it possible to retain high accuracies, even in highly multipath propagating environments. It can therefore greatly facilitate carrier phase ambiguity resolution, since the small code range errors reduce the search volume, while the decreased carrier range errors make it easier to reject false solutions.

Even though the MEDLL clearly shows a better performance than a conventional DLL, it does not completely eliminate all multipath errors. Especially multipath signals with small relative delays are difficult to estimate. So the MEDLL is approaching the theoretical accuracy limits, but it does not yet achieve them. Further improvements of the MEDLL, or integration with other techniques, e.g. [6], will hopefully further shrink the gap between practical and theoretical accuracy limits.

### REFERENCES

- [1] RDJ. van Nee, 'The multipath estimating delay lock loop', *Proceedings of the IEEE 2nd Int Symp on Spread Spectrum Techniques and Applications*, Yokohama, November 29 - December 2, 1992, pp. 39-42
- [2] RDJ. van Nee, 'Optimum DGPS receiver structures Proceedings of 2nd Int. Symp. on Differential Satellite Navigation ~~Star~~', Amsterdam, March 29 - April 2, 1993
- [3] RDJ. van Nee, 'GPS multipath and satellite interference', proceeding Of the ION 48th Annual Meeting Washington, June 29 - July 1, 1992. pp. 167-177.
- [4] P.C Fenton et al, Novatel's *GPS Receiver - The high performance sensor of the future* Proceedings of ION GPS-91, Albuquerque, September 11-13, 1991, pp.49-58
- [5] MS. Braasch and F. van Gnas, Guidance accuracy considerations *for realtime GPS interferometry* Proceedings of ION GPS-91, Albuquerque, September 11-13, 1991, pp.373-386.
- [6] J. Sennott and D. Senffner, The use of *satellite constellation geometry and a priori motion constraints for prevention of cycle slips in a GPS signal processor*, Proceedings of ION GPS-91, Albuquerque, September 11-13, 1991, pp.77-85.